

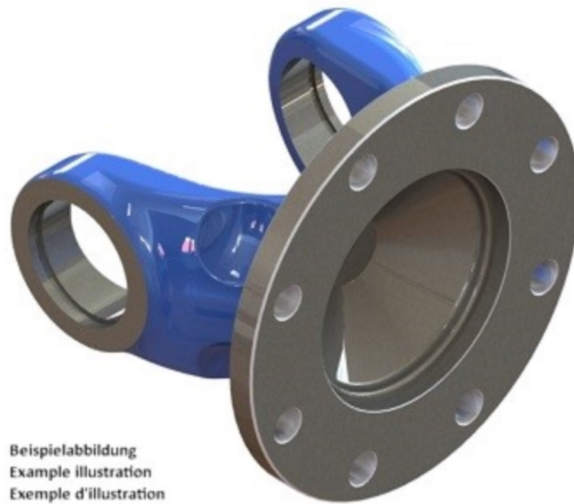

Artikelnummer identification code	<h1>0030601</h1>	Fotos und Bilder dienen nur der Veranschaulichung. Abweichungen in Farbe und Form sind möglich! Photos and figures are for illustration onla. Colour and design ist not guaranteed.
Gabelflansch DIN 225/8-16 / L1=095 für KR 52x133	flange yoke DIN 225/8-16 / L1=95 for UJ 52x133	

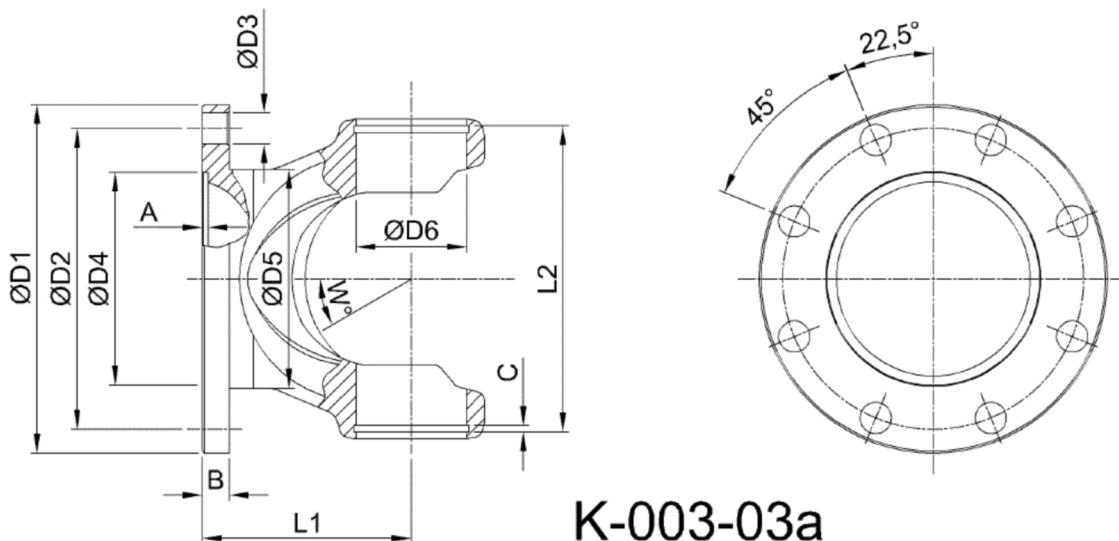

Beispielabbildung
Example illustration
Exemple d'illustration
Ilustración de ejemplo
Пример иллюстрации



K-003-03a

Gewicht: 0,000 kg

D1	225,00	L1	95,00	A	3,60	W	35°
D2	196,00			B	15,00		
D3	16,00						
D4	140,00						
D6	52,00						