

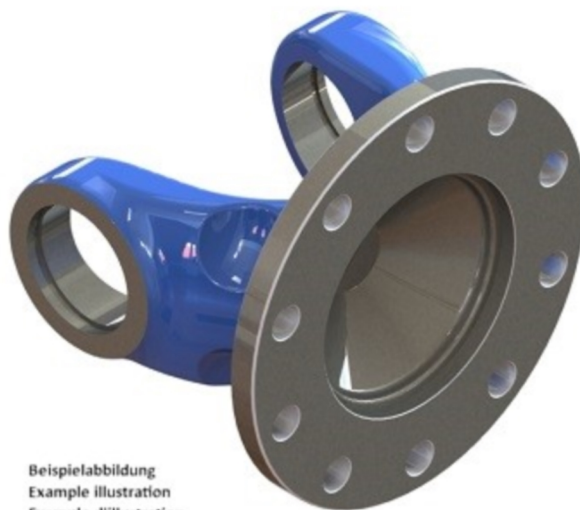

Artikelnummer identification code	<h1>0030495</h1>	Fotos und Bilder dienen nur der Veranschaulichung. Abweichungen in Farbe und Form sind möglich! Photos and figures are for illustration onla. Colour and design ist not guaranteed.
Gabelflansch DIN 180/10-16 / L1=85 für KR 57x152	flange yoke DIN 180/10-16 / L1=85 for UJ 57x152	

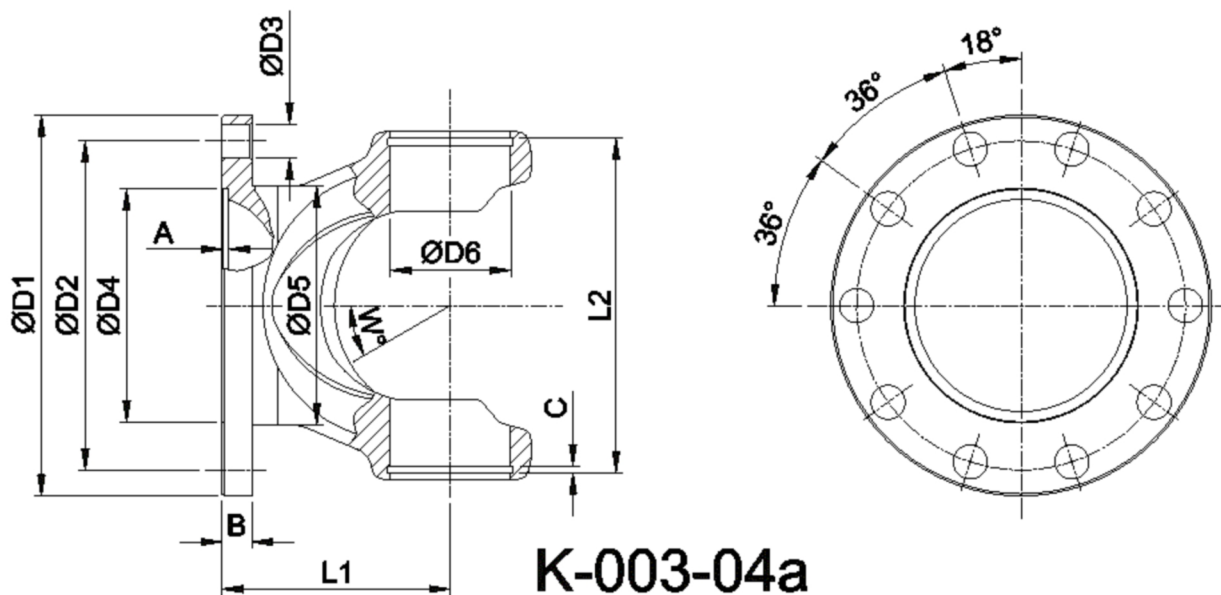

Beispielabbildung
Example illustration
Exemple d'illustration
Ilustración de ejemplo
Пример иллюстрации



Gewicht: 0,000 kg

D1	180,00	L1	85,00	A	3,00	W	20°
D2	155,50			B	14,00		
D3	16,00						
D4	110,00						
D6	57,00						