

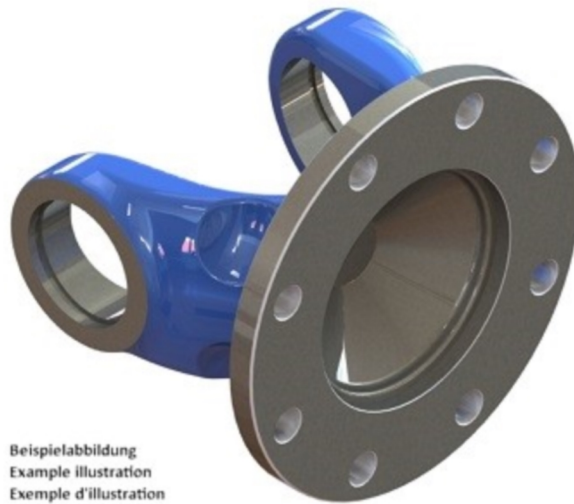

Artikelnummer identification code	<h1>0030293-1</h1>	Fotos und Bilder dienen nur der Veranschaulichung. Abweichungen in Farbe und Form sind möglich! Photos and figures are for illustration onla. Colour and design ist not guaranteed.
Gabelflansch DIN 120/8-10 / L1=60 für KR 42x106	flange yoke DIN 120/8-10 / L1=60 for UJ 42x106	

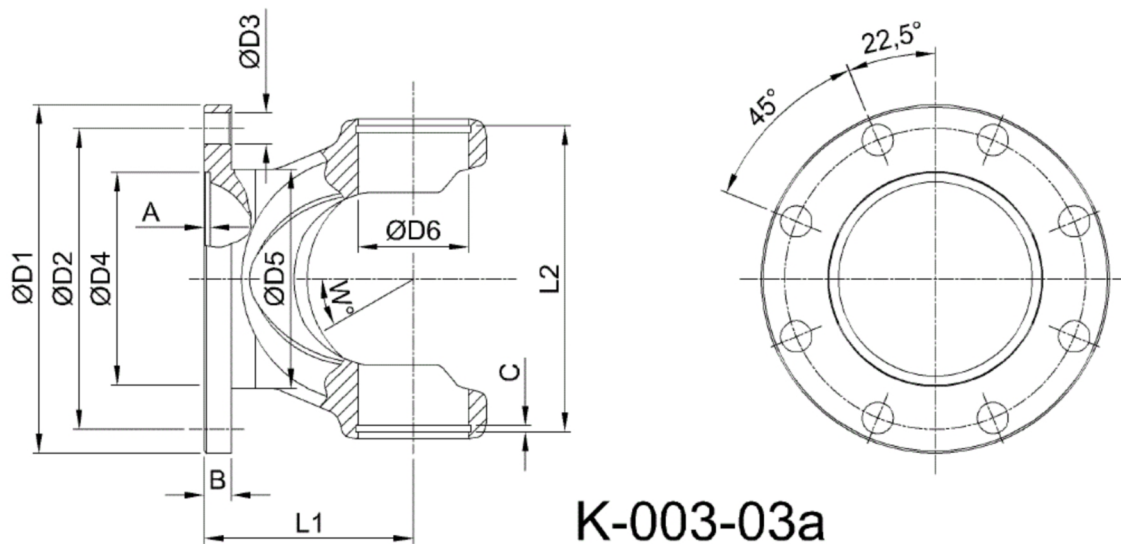

Beispielabbildung
Example illustration
Exemple d'illustration
Ilustración de ejemplo
Пример иллюстрации



K-003-03a

Gewicht: 2,100 kg

D1	120,00	L1	60,00	A	3,00	W	18°
D2	101,50			B	10,00		
D3	10,00						
D4	75,00						
D6	42,00						