

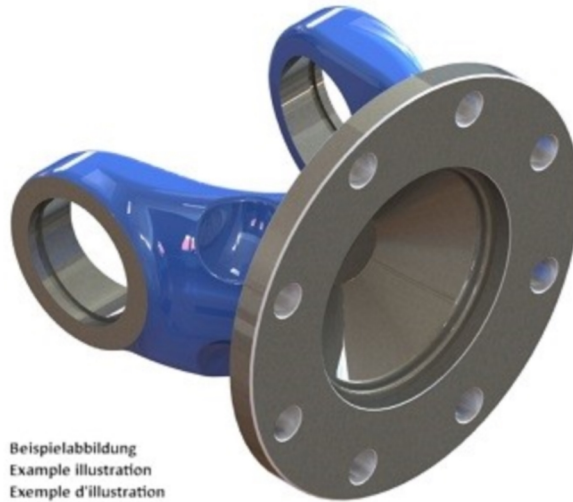

Artikelnummer identification code	0030292-1	Fotos und Bilder dienen nur der Veranschaulichung. Abweichungen in Farbe und Form sind möglich! Photos and figures are for illustration onla. Colour and design ist not guaranteed.
Gabelflansch DIN 150/8-12 / L1=90		flange yoke DIN 150/8-12 / L1=90
für KR 53x135		for UJ 53x135

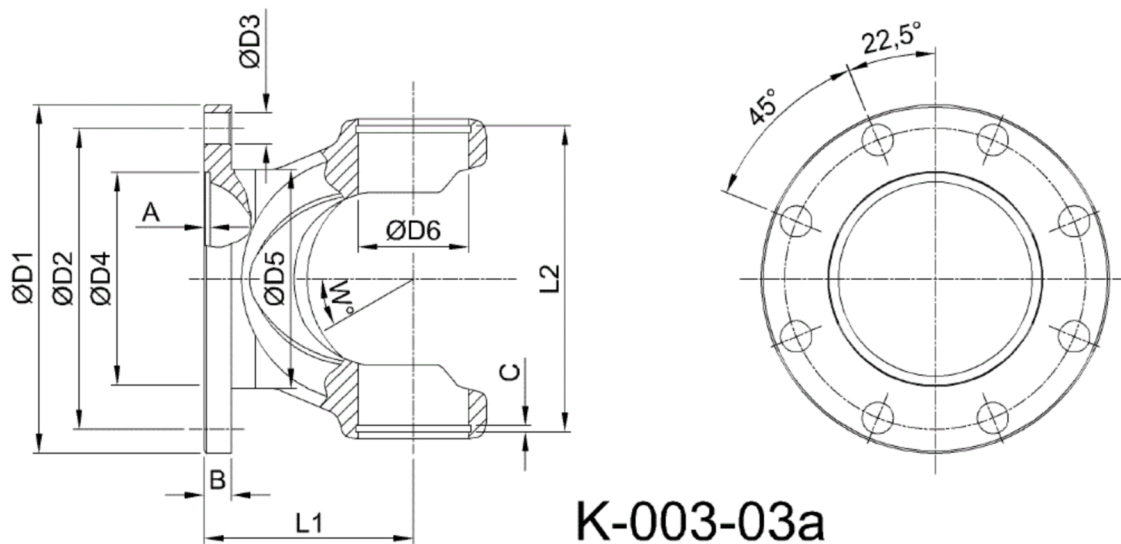

Beispielabbildung
Example illustration
Exemple d'illustration
Ilustración de ejemplo
Пример иллюстрации



K-003-03a

Gewicht: 4,600 kg

D1	150,00	L1	90,00	A	3,00	W	30°
D2	130,00			B	12,00		
D3	12,00						
D4	90,00						
D6	53,00						