

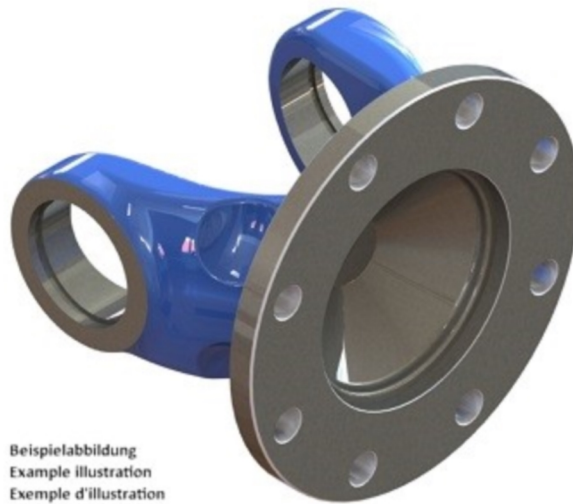

Artikelnummer identification code	<h1>0030198</h1>	Fotos und Bilder dienen nur der Veranschaulichung. Abweichungen in Farbe und Form sind möglich! Photos and figures are for illustration onla. Colour and design ist not guaranteed.
Gabelflansch DIN 285/8-20+2xM20 / L1=130 für KR 83x220	flange yoke DIN 285/8-20+2xM20 / L1=130 for UJ 83x220	

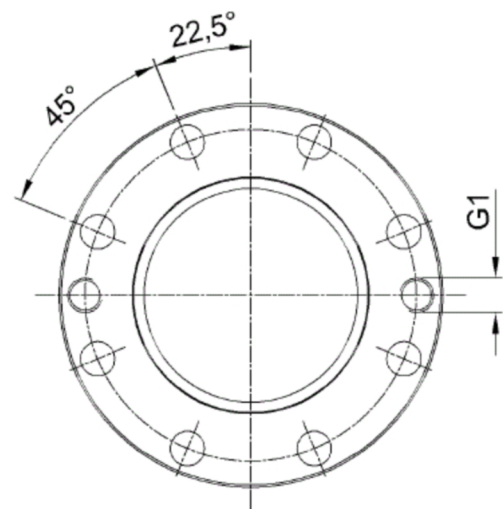

Beispielabbildung
Example illustration
Exemple d'illustration
Ilustración de ejemplo
Пример иллюстрации

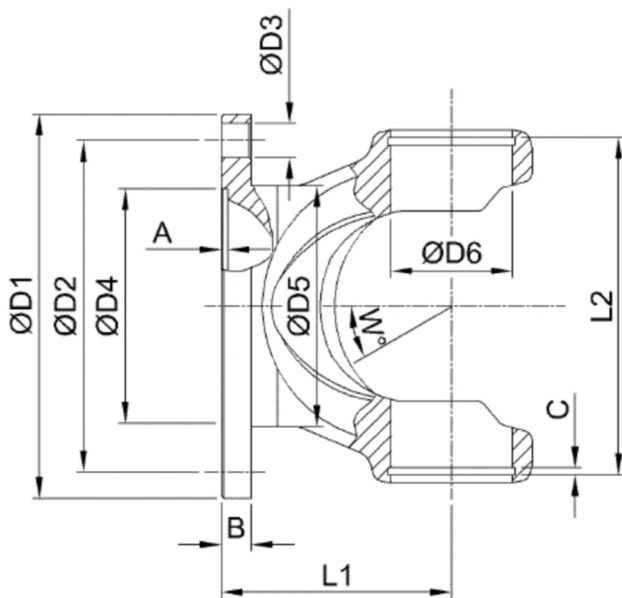

K-003-03c

Gewicht: 0,000 kg

D1	285,00	L1	130,00	A	7,00	W	18°
D2	245,00			B	20,00		
D3	20,00			G1	M20		
D4	175,00						
D6	83,00						